

HECON®  
**Quick-Key™**  
Series I, II & III  
**Business Equipment Monitoring Systems**

*Advanced Technology for Document Management*

Software driven *Single Station* and *Networkable* controllers for COPIERS, FAX, PRINTERS, Large Format Machines, Microfiche Machines and most other business equipment.

**Product Applications:**

- Universities, Colleges & Schools
- Copy Shops / Print for Pay
- Libraries
- Government Agencies
- Business Offices
- Real Estate Firms
- Churches
- Shared Offices
- Pre-Sell Environments



**High Tech Accessory Items, Inc.** is proud to offer advanced technology solutions for copier and print management. Through our alliance with Hecon, **High Tech** has provided leadership, direction and innovation for this industry and is recognized for offering the highest quality products available in the marketplace. By combining our industry knowledge and experience with many years of practical application, we offer our customers the highest quality products supported by outstanding service at extremely competitive prices.

# HECON<sup>®</sup> Quick-Key<sup>™</sup>

Say "Good-Bye!" to Jammed Copy and Unreliable Card Systems

## How it Works



Silicon memory chip inside the i-button™.

The HECON Quick-Key System is based on advanced semiconductor technology that allows instant and foolproof access to an unlimited number of users and an unlimited number of copiers, printers fax machines, etc.

The HECON Quick-Key 'button' (ibutton™) is a nonvolatile, silicon memory chip packaged in a rugged, stainless steel, miniature container with a sealed lid. This rugged and durable button preserves the chip even when subjected to corrosive conditions. These buttons are rated for over 150 million read/write cycles, *this can be up to 50,000 times greater than that of magnetic cards or chip cards.*

When touched, information is instantly transferred, verified and stored (after acceptable data integrity is confirmed). Buttons can be submersed in liquid, hit with up to ±10,000 volts of static electricity, exposed to severe temperatures or be subjected to the magnetic fields that would destroy the integrity of any magnetic card. The i-button™ benefits from a high-volume, low-cost packaging methodology known for its excellent ability to preserve contents.

The Buttons interact with HECON Quick-Key Controllers by touching them to the Controller's receptacle. The receptacle is a single surface, bright, tarnish-resistant metal that provides for millions of operations. Simply by 'touching' the button to the Controller, you enable the copier or printer. The button contents change as copies or prints are made, and the ability to make copies or prints is disabled when the button is empty. Buttons can be reused almost indefinitely.

There are absolutely no moving parts in the Controller (Reader). They are impossible to "jam" and contain static components that will not break or wear out. HECON Quick-Key technology is light years ahead of popular competing technologies and has redefined copy and print management.

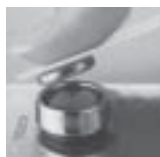

## Benefits and Features

- **Guaranteed for the Life of the Copier or Printer**
- **Guaranteed Data Integrity**
- **Half the Price of Comparable Systems**
- **Maintenance Free Technology**
- **No Moving Parts**
- **Exceptional Durability**
- **Quick, Error-Free Access**
- **Interfaces to Any Copier and Most Printers**
- **Lost Key Protection and Reclamation**
- **Full Reporting Capabilities**
- **Networkable**
- **Compatible With All Major Operating Systems**

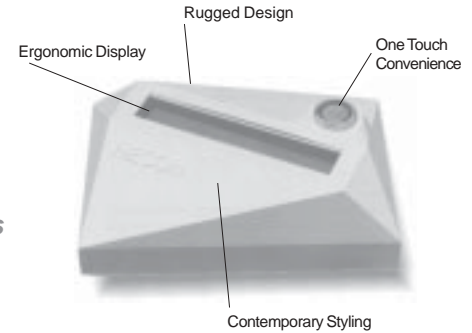

The HECON Quick-Key Controller

## Available in three different versions, Series I, II and III

There is a HECON Quick-Key solution designed to tackle just about any type of copy and print application. This technology thrives on applications that are looking for less administrative interaction and increased product reliability.

For over ten years **High Tech Accessory Items, Inc.** has been installing and maintaining HECON Quick-Key systems throughout the USA. We specialize in integrating this technology into school systems, colleges and federal, state and local governments.

HECON Quick-Key technology continues to demonstrate its robust set of benefits and features among county government applications involving public record keeping. This includes providing *affordable solutions* that can be included in just about any budget, including yours!

Superior technology is backed by 'street-level' experience that can only come from being intimately involved in all the details of each installation. Our technology does its part by eliminating product failure... The people at High Tech A.I. provide you with experienced professionals to do the rest.

CHARACTERISTICS	SERIES I	SERIES II	SERIES III
Max. Number of Acct. Numbers	unlimited	unlimited/debit 6,900 credit	unlimited/debit 15,000 credit
Customized ID Fields (Depts.)	unlimited	unlimited	unlimited
Number of Quick-Key Functions	4*	6**	6**
Type of Quick-Keys Used	Model 2	Model 1, Model 2	Model 1, Model 2
Method of Transfer	card/stack probe	link cable	link cable
Memory Storage	button	button/controller	button/controller
User Defined Groups	4	4	4
Max. # of Controllers per System	unlimited	unlimited	unlimited
Number of Fields per User Record	10	10	10
Number of Defined Cost Per Copy	8***	8***	8***
Number of Reports	11	13	13
Customizing Reports	yes	yes	yes
ASCII Import/Export	yes	yes	yes
Disable/Find Key Function	yes	yes	yes
Copy Limits (Individual)	no	yes	yes
Copy Limits (Controller)	yes	yes	yes
Run Limits	yes	yes	yes
Integrated Data	yes	yes	yes
On-Line Manual	yes	yes	yes
Maintenance Required	none	none	none

## HECON Quick-Key speaks for itself...

"...prior to installing the Quick-Key copy and print management system we had a magnetic card system. There wasn't a day that would go by when we didn't receive complaints about jammed or unusable cards, since we've installed the Quick-Key system these problems have disappeared. I highly recommend this product to anyone thinking about using a card system."

Denis Buckley, McGraw Hill Printing, NYC, NY

## oin Boxes, Making ystems.

The HECON Quick-Key system provides for almost limitless flexibility in how you set up your system. The new Quick-Key Software developed by High Tech installs on any Windows or DOS based PC and allows for complete management and tracking.

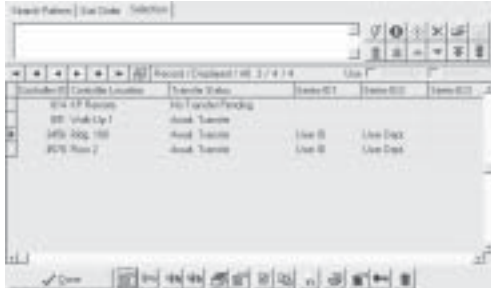

QK Software - Controller Status Window

The heart of the system is the software which makes setup, configuration and operation of the system a breeze - just point and click!

Access and User Data, such as ID, Name, Account Number, Address, Department, Phone Number, etc., is all managed through well thought out menu-driven navigational design.



QK Software - User Status Window

Transferring information from the administrating PC to HECON QK buttons is accomplished via the PC Interface, which attaches to the PC's serial port.

Transferring and gathering information to and from the Controllers/Readers can be accomplished via a Probe, Link Cable or by creating a network. Our network software can accommodate both internal and external locations through the use of network nodes and modems. The software also has a built in auto-configuration feature making network setup for your IS department a breeze.

## Accessory Products

### Reset Controller

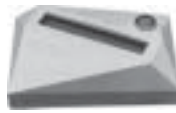

The Reset Controller enables an administrator to reset a button programmed in credit mode back to zero. This

is a stand-alone unit that simply plugs into any standard power outlet. The unit displays the number of copies made on Credit Buttons. Once a button is touched and the value is displayed, the value on the credit button is automatically reset to zero. The display on the controller will show the last amount until a programmable timeout is reached or a different button is touched. This product is frequently used in applications to display usage for walk-in, self-serve copier customers.

### Vending and Revalue Stations

Other accessory items for this system include the Vending and Revalue Stations. These products provide simple and reliable *unattended* vending. It allows users



to purchase and revalue their buttons by using cash at self-access locations. The Revalue Station can be used independently to revalue a user's button or together with the Vending Station. The Vending Station can dispense a button to a user with values that the system administrators can preprogram themselves.

### Cash Station

The Cash Station enables a user to debit a dollar amount from a user's button. This stand alone unit is most often used in conjunction with a cash register. The Cash Station charges already existing debit value buttons with any amount entered in through the integrated keypad. An LCD display shows the amount being debited and also prompts the user through the setup process.



The Cash Station also keeps a total of the value charged from all buttons used at the station. The integrated resettable totalizer can be used to reconcile totals from the cash register. There is a port to connect our portable printer for hard copy reports on totals and the balance of up to 1,700 buttons used at the station. There is also a function to allow a supervisor to correct transactions and credit amounts back to a button.

### Quick-Key™ Buttons



There are two versions of the HECON Quick-Key button available. *Model 1* buttons are designed for credit use only and store information directly

in a Series II and III Controller, whereas *Model 2* (credit/debit format) buttons store information in the button's memory itself and work with all Controllers.

### Mounting Devices

The Card Mount, Key Chain Mount (Fob) and Ultra High Strength, Self-



Stick Tape Pads (tape pads not pictured here) are three different ways High Tech

provides for mounting buttons. A button can also be mounted on an existing key ring, ID card, badge, or any other flat surface.



### Button Security Tag



Our Security Tag provides for secure mounting of buttons in situations where they are being used in public environments.

For example, walk-up copier applications in print shops, libraries and government public record areas.

### Mounting Brackets

There are two mounting bracket styles available to secure Controllers to or near the copier. Top/Front or Rear brackets make the Controller an



integral part of the copier while providing optimal placement for daily use. Mounting brackets are made of heavy gauge steel to provide you with the most secure mounting possible.

All necessary hardware is included along with instructions on how to mount the brackets to the machine.

*“Say good-bye to Coin-Op and Magnetic Cards...HECON Quick-Key has them all beat.”*

\* credit units, credit value, debit units, debit value  
\*\* credit units, credit value, debit units, debit value, credit id, credit limit  
\*\*\* per copier

# DATA COMMUNICATION - 4 WAYS TO CONNECT (For Series II and III)

There are four options available for communication with the HECON Quick-Key™ System. They include: direct connection, modem direct, local node network (LAN) and modem/node network.

## Option 1 - Direct Connection

Enables information to be transferred to and from each controller via a Link Cable connected to a laptop.

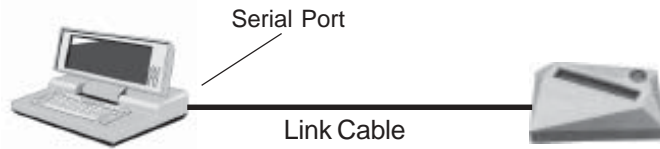

## Option 2 - Modem Direct

Links controllers to a computer using analog phone lines, from building to building or across the country.

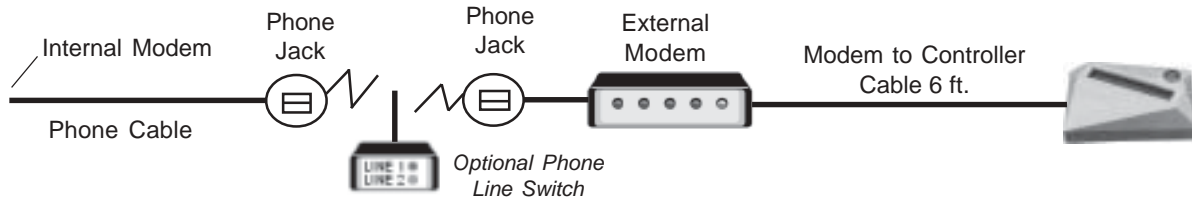

## Option 3 - Local Node Network (LAN)

Links controllers to a computer by using nodes which are connected by dedicated, 6-wire phone cable. Nodes can be up to 1000 feet apart.

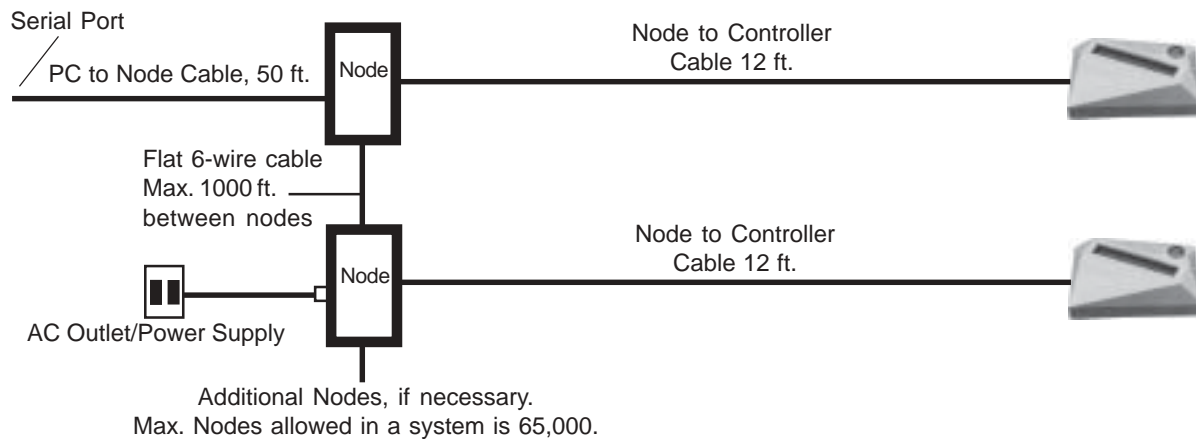

## Option 4 - Modem/Node Network

Links controllers to computer by utilizing both modems and nodes from building to building or across the country.

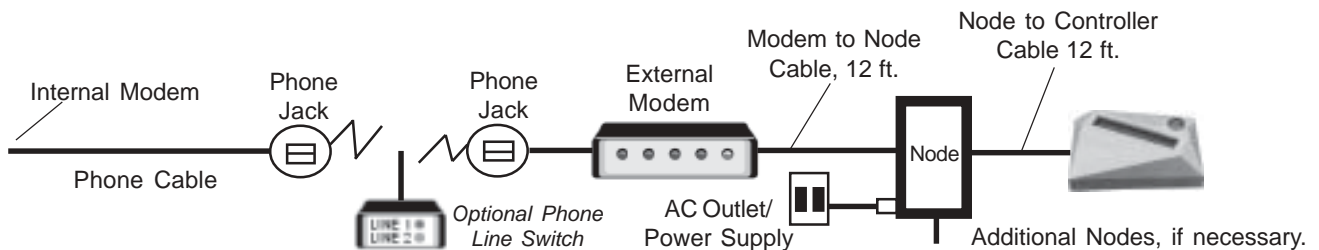

## Minimum System Requirements

- Pentium processor, 100 MHz minimum, running Windows® 95 or higher OS.
- 32 MB RAM minimum.
- Hard drive with at least 12 MB of free space for software application. Additional hard drive space needed will be dependent upon controller data, user records and copy usage data.